

> GARGOLAS

Gárgola Standard de Hormigón para Desagüe

GSHD-030

30 X 14.5 X 16.3

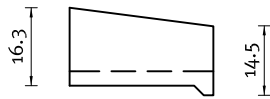

VISTA LATERAL

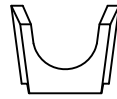

VISTA FRONTAL

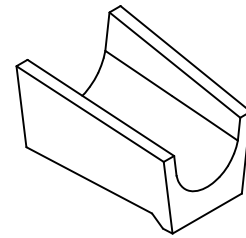

PERSPECTIVA

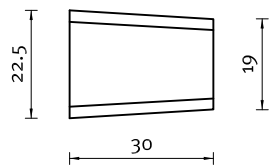

PLANTA

7.3 kg

Gárgola Standard de Hormigón para Desagüe

GSHD-050

50 X 14.5 X 19

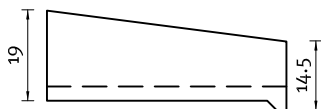

VISTA LATERAL

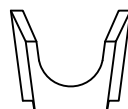

VISTA FRONTAL

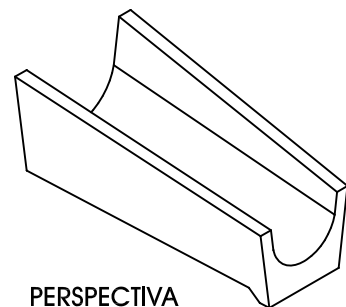

PERSPECTIVA

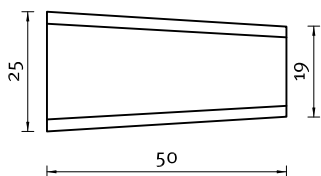

PLANTA

14.1 kg

Notas
